



HANSEN M5CT

Right Angle gearboxes dedicated for
Cooling technology / Fan drive solutions



Table of contents

1	Features	2
1.1	Advantages of Hansen M5CT Cooling Technology series	2
1.2	Technical Information	2
2	Description	3
2.1	The gear unit	3
2.2	Coding	3
2.3	Basic components	4
2.4	Systems	4
2.5	Motors	5
2.6	Optional devices	5
2.7	Shipping conditions	5
2.8	Protection	5
3	Selection	6
3.1	Mechanical power rating	6
3.2	Thermal power rating	7
4	Mechanical power ratings P (kW)	8
5	Rated thrust load F_{xN} (kN)	9
6	Thermal power ratings P (kW)	10
7	Exact ratio's i_{ex} and moments of inertia J	11
7.1	Exact Ratios i_{ex}	
7.2	Moments of inertia J related to the "High Speed Shaft"	11
8	Dimensional drawing	12

Copyright Sumitomo (SHI) Cyclo Drive Germany GmbH 2023.

All rights reserved. Copying, including extracts, is only permitted with our approval. The information in this catalogue has been checked for correctness with extreme care. However, no liability can be accepted for any incorrect or incomplete information.

We reserve the right to make modifications.

Image credits: shutterstock

1 Features

1.1 Advantages of Hansen M5CT Cooling Technology series

- Dedicated industrial gearbox**
 Best possible fit for fan drive applications:
 e.g. Wet Cooling Towers, Air Cooled Condensers (induced draft types) and Direct Air Capturing.
- Designed in accordance with CTI standards**
 Manufactured to be compliant with Cooling Technology Institute (CTI) specifications
- Best out of Hansen P4, Hansen M4ACC and PARAMAX SFC**
 Rely on decades of experience and more than 20.000 installations in the field
- Rigid housing, dynamic stability**
 Smooth transition of high axial loads coming from the rough application
- Optimized gearing from Hansen P4 range**
 Proven design, maximum load capacity, minimum losses and quiet operation
- Advanced design to withstand the peak fluctuations during start-up**
 Selection method taking starts and stops into account, specifically for ACC applications
- Reliable lubrication and sealing, less maintenance**
 Oil lubrication without outside pipes, Oil seal hood for reliable protection against the ingress of dust & water
- High resistance in corrosive and extreme humidity environments**
 Standard high-quality paint conform ISO C5 corrosion category, stainless steel bolts, use of durable instruments
- Numerous instruments & accessories**
 E.g. Optional condition monitoring: Temperature, oil flow and vibrations



1.2 Technical Information

13 - 53 kNm

Output Torque

7 sizes

Dedicated

2-stages

Right-angle

6.3 - 22.4

Reduction Ratios

Size Range	CA	DA	DX	EA	EX	FA	FX
Nominal Output Torque	13 kNm	18 kNm	23 kNm	28 kNm	36 kNm	41 kNm	53 kNm
Output shaft Direction	Vertical upward						
Shaft type	Solid shaft						
Shaft configuration	Right Angle						
Gears	Helical and Bevel gears - designed and rated in accordance with AGMA						
Housing Type	Dedicated housing with integrated cooling fins						
Lubrication Type	Standard oil splash and optional pump, both without outside piping						
Bearings output shaft	Extended Bearing span with heavy-duty roller bearings						
Input speed	Up to 1800 rpm						

2 Description

2.1 The gear unit

Units are designed to comply with the standard CTI specifications for gear units. The mechanical power ratings shown in the tables relate respectively to input speeds of 1800, 1500, 1200, 1000, 900 and 750 RPM at the high speed shaft and are only valid for low speed shaft rotating clockwise. They are also valid for asynchronous speeds which are max. 3% lower than the synchronous speeds. Interpolation will yield power rating values for intermediate speeds. The power rating for speeds lower than 750 RPM is based on the continuous torque rating of that speed. For input speeds exceeding 1800 RPM, please refer to us.

2.2 Coding

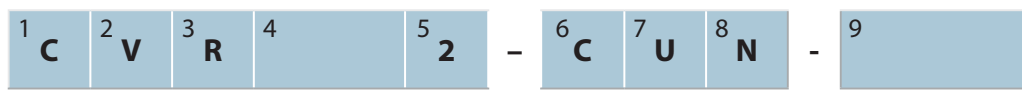

Type

1	Series:	C: Hansen M5CT
2		V: vertical low speed shaft
3		R: right-angle shafts
4		Size: CA, DA, DX, EA, EX, FA, FX
5		Number of stages: 2

Shaft arrangement

6	High speed shaft extension:	C: right-angle
7	Low speed shaft extension:	U: up
8	Low speed shaft type:	N: normal solid shaft

Ratio

9	Nominal ratio
---	---------------

2.3 Basic components

Designed and rated:

- based on AGMA, ISO and long term field experience;
- for maximum load capacity, minimum losses and quiet operation.

The rating tables show the mechanical power ratings P expressed in kW, i.e. the power which the gear unit can transmit during 10 h/day, at uniform load.

The mechanical power ratings shown in the tables relate respectively to input speeds of 1800, 1500, 1200, 1000, 900 and 750 rpm at the high speed shaft. They are also valid for full load speed which are max. 3 % lower than the synchronous speeds.

Interpolation will yield power rating values for intermediate speeds. The power rating for speeds lower than 750 rpm is based on the continuous torque rating of that speed.

For input speeds exceeding 1800 rpm, please refer to us.

All geared components are manufactured from alloy steel, gas carburized, hardened and ground.

The same applies to all intermediate and high speed shafts which are generally designed as pinion shafts.

Low speed shafts

The low speed shafts are in solid version.

Extended shafts are available upon request.

For all executions, input and output shafts are located in the same vertical plane.

Bearings

Heavy duty roller bearings of the tapered, cylindrical or spherical roller type.

Calculated in compliance with ISO and renowned bearing manufacturers.

The low speed shaft bearings are selected to allow considerable thrust loads. The nominal permissible thrust load F_{xN} mentioned in the tables ("5 Rated thrust load FXN (kN), page 9) is defined for a SFmin = 2, low speed shaft rotating clockwise and guarantees a calculated bearing life of 100000 hours.

Housings, bearing housings and covers

Made from grey pearlitic cast iron.

Machined on CNC machining centers.

Designed to ensure strength and rigidity.

Unused tapped holes are plugged.

Monobloc housing.

2.4 Systems

Lubrication

Lubricants: Synthetic-, mineral- or bio oils are normally used. Refer to service manual for specified list of lubricants and EP-additives.

Splash lubrication for the upper bearings is standard.

Pump lubrication is optionally available. Refer to us for minimum speed and operating temperatures.

The lubrication system is appropriate for wind milling conditions.

The gear units housing acts as a large oil sump.

Checking of the oil level is done by means of the gear unit dipstick (always in the plugged position).

A breather plug is installed to prevent a too high pressure in the gear unit.

Make sure that the breather operates outside the humid area.

Cooling

Heat generated in the gear unit due to losses, can be dissipated by:

- Natural cooling through the housing
- Additional fan cooling: a shaft driven axial fan can be incorporated at the input shaft (option). Free air entry at the suction side should be guaranteed
- Possibility to integrate other cooling options (e.g. cooling group)

For thermal check, refer to tables.

Sealing

Static:

- Generalized use of sealing compound
- Inspection cover: O-ring

Rotary:

- High speed shaft: standard : dust lip oil seal
- Low speed shaft: - dust lip oil seal
- oil seal hood

Other sealing systems as option possible.

2.5 Motors

Right-angle gear units are driven by foot mounted IEC motors (type B3).

Use of two speed motors: when changing speed with two speed motors, the motor has to be slowed down below the low speed, before energising the slow speed winding.

2.6 Optional devices

Some devices can optionally be provided.

More detailed information about the optional devices is mentioned in separate technical manuals. Refer to us.

Backstop

Built-in backstop to prevent the fan from "wind-milling". Internal lubrication is assured.

Filter

With incorporated pressure relief valve.

A filter with incorporated pressure relief valve and visual or electrical contamination indicator is available as an option.

Heaters

Electrical heating devices for low temperature start-up are available.

Pressure switch or pressure transmitter

To control the oil pressure, a pressure switch or pressure transmitter can be provided. They can trigger an alarm signal when the oil pressure falls beneath a specified limit.

Pt100

To control the oil bath temperature. The Pt100 can trigger an alarm signal when the oil temperature is higher than a specified limit.

Oil level switch

To control the oil level in the gear unit, an oil level switch can be provided. This switch can trigger an alarm signal when the oil bath falls beneath a specified limit.

2.7 Shipping conditions

Inspection prior to shipment

- Test run: all gear units are tested under no load
- Conformity Check

Protection

- Shaft extension: greased.

Lubricants

- Hansen M5CT gear units are shipped without oil.

For information relating to storage, handling, installation, start-up and maintenance, refer to the service manual which is supplied together with each gear unit.

2.8 Protection

Standard protection systems

- As a standard, Hansen M5CT gear units are provided with a painting system that is suitable to be applied in the atmospheric-corrosivity category "C5" according to ISO 12944. The choice of colour has no influence on the technical quality of the painting system. Other painting systems can be offered to meet the required atmospheric-corrosivity category for your application.
- Bolts and nuts provided with appropriate protection.

Aggressive environment

For wet cooling tower and air cooled condenser drives in aggressive environment, an additional protection system can be offered: refer to us.

3 Selection

3.1 Mechanical power rating

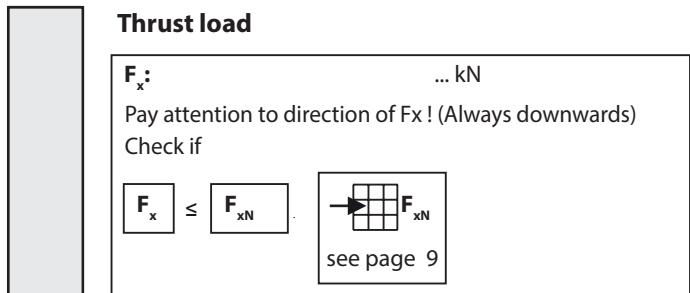
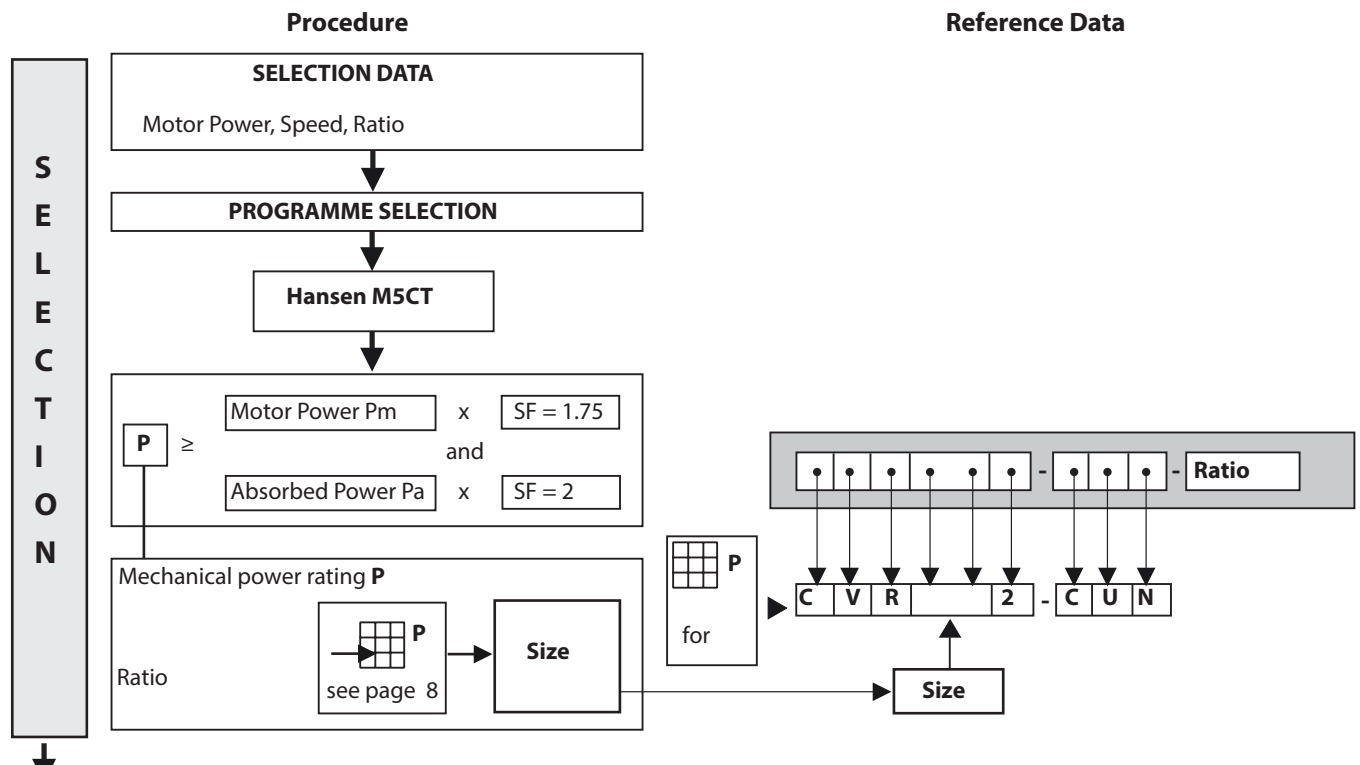

Thermal rating see pages 10

Start-up Torque & Time

Gear Unit micro geometry will be checked for nominal motor torque for normal operation and for 1.5 times mechanical AGMA torque of the gear unit for startup conditions.
In case higher torques are expected during operation or during startup, please specify.

Total allowed starting time (sum of starting cycle) is determined, based on customer's information, according to methods described in the standard (AGMA 2101-D04 paragraph 7.2 - Miner's rule).

3.2 Thermal power rating

Procedure

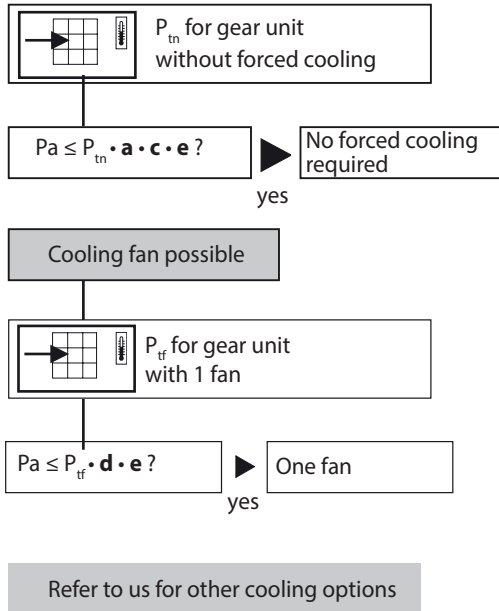

Reference Data

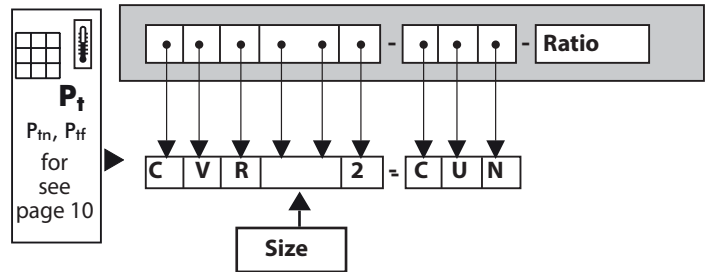

Factor **a** for ambient temperature without forced cooling

Reduction	Ambient temperature in °C			
	Ratio	15 to 25	25 to 35	35 to 45
6.3 → 1.2	1	0.81	0.68	0.55
12.5 → 18	1	0.85	0.71	0.66
≥ 20	1	0.87	0.75	0.74
Size	CA ▶ FX	CA ▶ FX	CA ▶ DX	EA ▶ FX

Factor **c** for air circulation (without fan)

Mounting	Mounting		
Indoors- small enclosure	≥ 0,5 m/s	0.73	0.70
Indoors- normal working areas	≥ 1,4 m/s	1	1
Outdoors- protected against sun	≥ 3,0 m/s	1.33	1.36
Size		CA ▶ DX	EA ▶ FX

Air flow to be selected according to the structure:

Open structure: gear units installed in an open steel frame structure allowing the cooling tower air flow to pass over the gear unit's housing.

Closed structure: gear units installed on a solid concrete plinth or enclosed steel frame. This structure prevents the cooling tower air flow from passing over the gear unit's housing.

Factor **d** for ambient temperature with forced cooling

	Number of stages	Ambient temperature in °C			
		15 to 25	25 to 35	35 to 45	45 to 55
with forced cooling	2	1	0.86	0.72	0.59

Factor **e** for relative air humidity

Relative air humidity	
< 100 %	= 100 %
1	1.15

4 Mechanical power ratings P (kW)

Ratio ¹⁾	SPEED ²⁾	Size						
		CA	DA	DX	EA	EX	FA	FX
6.3	1800	350	600		810		1050	
	1500	310	510		710		910	
	1200	260	410		580		740	
	1000	220	340		490		610	
	900	200	310		440		550	
	750	170	260		370		460	
7.1	1800	320	530		730		1000	
	1500	280	440		640		890	
	1200	235	360		550		740	
	1000	200	300		460		610	
	900	180	270		420		550	
	750	150	225		350		460	
8	1800	300	480	600	690	810	900	1050
	1500	255	400	500	610	710	790	910
	1200	210	330	410	510	580	680	740
	1000	180	275	340	430	490	580	610
	900	165	245	310	390	440	530	550
	750	140	205	255	320	370	450	460
9	1800	275	420	520	620	720	850	1000
	1500	235	350	430	550	630	750	890
	1200	190	285	350	440	540	640	740
	1000	160	240	290	370	450	540	610
	900	145	215	265	330	410	490	550
	750	120	180	220	280	340	410	460
10	1800	250	390	480	580	680	760	900
	1500	210	320	400	500	600	670	790
	1200	175	260	320	410	500	560	680
	1000	150	215	270	340	430	480	580
	900	135	200	245	310	390	430	530
	750	115	165	205	260	330	370	450
11.2	1800	225	340	410	520	610	730	850
	1500	190	280	350	440	540	640	750
	1200	155	225	280	360	430	530	640
	1000	130	190	235	300	360	440	550
	900	115	170	210	270	330	400	500
	750	97	145	175	225	275	330	420
12.5	1800	195	310	380	470	570	640	760
	1500	170	260	320	400	490	550	670
	1200	140	210	260	330	410	450	560
	1000	120	175	215	275	350	380	480
	900	105	155	195	250	320	350	430
	750	91	130	165	210	265	295	370
14	1800	180	275	330	420	520	610	730
	1500	150	230	275	360	430	520	640
	1200	120	185	220	285	350	420	530
	1000	100	155	185	240	295	350	450
	900	92	140	165	220	265	320	410
	750	77	115	140	180	220	265	340
16	1800	145	220	310	380	470	510	640
	1500	120	185	260	320	400	420	550
	1200	97	150	210	255	330	340	450
	1000	82	125	175	215	280	285	380
	900	74	110	155	195	255	260	350
	750	62	94	130	160	215	215	295
18	1800	145	215	265	330	420	500	610
	1500	120	180	225	280	350	420	520
	1200	96	145	180	225	280	340	430
	1000	80	120	150	190	235	280	360
	900	72	110	135	170	210	255	330
	750	60	91	115	140	175	210	275
20	1800			220		370		510
	1500			185		320		420
	1200			150		255		340
	1000			125		215		285
	900			110		195		260
	750			94		160		215
22.4	1800			210		330		500
	1500			175		275		420
	1200			140		220		340
	1000			120		185		285
	900			105		165		260
	750			89		140		215

1) Nominal Ratio

2) Nominal Speed input shaft (rpm)

5 Rated thrust load F_{XN} (kN)

		Size						
Ratio ¹⁾	SPEED ²⁾	CA	DA	DX	EA	EX	FA	FX
6.3	1800	28	27		44		78	
	1500	28.5	28		44		79	
	1200	29	29		45		81	
	1000	30	30		47		84	
	900	30	31		48		85	
	750	31	32		49		87	
7.1	1800	28	27		43		78	
	1500	28.5	28		43		79	
	1200	29	29		44		81	
	1000	29.5	30		45		84	
	900	30	31		46		85	
	750	31	32		47		87	
8	1800	28.5	28.5	47	44	72	79	90
	1500	29.5	29.5	49	45	73	80	90
	1200	30	30	50	46	74	82	90
	1000	31	31	52	47	76	84	90
	900	31	32	53	48	77	85	90
	750	32	33	55	49	79	87	90
9	1800	28.5	28.5	48	44	70	80	90
	1500	29	29.5	50	44	71	81	90
	1200	30	31	51	45	74	83	90
	1000	31	32	53	47	76	85	90
	900	31	32	54	48	77	86	90
	750	32	34	55	49	80	88	90
10	1800	29.5	29	49	46	71	81	90
	1500	30	31	51	47	72	82	90
	1200	31	32	53	48	75	84	90
	1000	31	33	54	49	77	86	90
	900	32	33	55	49	79	87	90
	750	33	35	57	51	80	89	90
11.2	1800	29	29.5	50	45	72	81	90
	1500	30	31	51	46	74	83	90
	1200	31	32	53	47	77	85	90
	1000	32	33	55	48	79	87	90
	900	32	34	56	49	80	88	90
	750	33	35	58	51	80	90	90
12.5	1800	30	31	51	47	73	83	90
	1500	31	32	53	48	75	84	90
	1200	32	33	54	49	77	87	90
	1000	33	34	56	50	80	89	90
	900	33	35	57	51	80	90	90
	750	35	37	58	52	80	90	90
14	1800	30	31	52	46	74	83	90
	1500	31	32	53	47	77	85	90
	1200	32	33	55	49	79	88	90
	1000	33	34	57	50	80	90	90
	900	34	35	58	51	80	90	90
	750	36	38	59	53	80	90	90
16	1800	32	34	53	49	75	85	90
	1500	33	35	54	50	77	88	90
	1200	34	36	56	51	80	90	90
	1000	36	38	58	53	80	90	90
	900	37	40	59	54	80	90	90
	750	39	43	59	57	80	90	90
18	1800	31	32	54	48	77	86	90
	1500	32	33	55	49	79	88	90
	1200	33	35	57	51	80	90	90
	1000	36	37	59	52	80	90	90
	900	37	39	59	54	80	90	90
	750	40	42	59	59	80	90	90
20	1800			57		79		90
	1500			58		80		90
	1200			59		80		90
	1000			59		80		90
	900			59		80		90
	750			59		80		90
22.4	1800			56		80		90
	1500			58		80		90
	1200			59		80		90
	1000			59		80		90
	900			59		80		90
	750			59		80		90

1) Nominal Ratio

2) Nominal Speed input shaft (rpm)

6 Thermal power ratings P (kW)

Ratio ¹⁾	SPEED ²⁾	fan ³⁾	Size						
			CA	DA	DX	EA	EX	FA	FX
6.3 ↓ 9	1800	-	100	105	140	125	150	85	120
		1	275	380	450	510	560	680	730
	1500	-	110	135	165	165	190	175	200
		1	250	350	420	470	520	630	690
	1200	-	115	145	175	190	210	225	245
		1	225	310	380	410	470	570	630
	1000	-	115	145	180	190	220	240	265
		1	205	280	340	370	430	520	580
	900	-	115	145	180	190	220	240	270
	1	190	265	320	350	410	490	550	
	750	-	110	145	175	185	215	240	270
		1	170	240	295	320	370	440	500
10 ↓ 14	1800	-	89	110	140	145	175	170	185
		1	210	295	380	410	500	560	670
	1500	-	92	115	150	155	190	185	220
		1	195	270	350	370	450	510	610
	1200	-	91	115	150	155	195	195	235
		1	170	240	310	330	400	450	540
	1000	-	88	115	150	155	190	195	235
		1	150	215	280	300	360	400	490
	900	-	86	115	150	155	190	195	235
	1	145	200	260	280	340	380	460	
	750	-	83	110	145	150	190	190	230
		1	130	180	235	250	310	340	410
16 ↓ 22.4	1800	-	78	94	110	130	145	160	170
		1	180	245	275	350	370	490	510
	1500	-	78	97	115	135	145	165	180
		1	160	220	250	320	340	440	460
	1200	-	77	97	115	135	150	170	185
		1	140	195	220	280	295	390	410
	1000	-	74	95	110	135	145	170	185
		1	125	175	195	255	265	350	360
	900	-	73	93	105	130	145	170	185
	1	120	165	185	235	250	330	340	
	750	-	69	90	100	125	135	165	175
		1	105	145	165	210	225	295	310

1) Nominal Ratio

2) Nominal Speed input shaft (rpm)

3) Fan on input shaft: (-) No fan or (1) One fan, correction factors see page 7

7 Exact ratio's i_{ex} and moments of inertia J

7.1 Exact Ratios i_{ex}

$iN^{1)}$	i_{ex}						
	Size						
	CA	DA	DX	EA	EX	FA	FX
6.3	6.2701	6.4572		6.1765		6.4323	
7.1	7.2059	7.2995		7.1061		6.9667	
8	7.8824	8.1176	8.0481	7.7647	7.7674	8.3097	8.0156
9	9.0588	9.1765	9.0775	8.9333	8.9091	9	8.6556
10	9.737	10.266	10.118	9.7059	9.7647	10.263	10.355
11.2	11.19	11.606	11.412	11.167	11.2	11.116	11.182
12.5	12.387	12.718	12.796	12.165	12.206	12.949	12.789
14	14.235	14.376	14.433	13.996	14	14.025	13.811
16	15.765	16.235	15.851	15.529	15.298	16.25	16.137
18	18.118	18.353	17.878	17.867	17.547	17.6	17.425
20			20.235		19.529		20.25
22.4			22.824		22.4		21.867

1) Nominal Ratio

7.2 Moments of inertia J related to the "High Speed Shaft"

$iN^{1)}$	J (kgm ²)						
	Size						
	CA	DA	DX	EA	EX	FA	FX
6.3	0.0595	0.124		0.228		0.441	
7.1	0.0562	0.118		0.214		0.426	
8	0.0508	0.104	0.141	0.197	0.263	0.36	0.509
9	0.0487	0.1	0.133	0.189	0.241	0.35	0.486
10	0.0416	0.081	0.114	0.154	0.219	0.286	0.401
11.2	0.0403	0.0788	0.109	0.148	0.206	0.28	0.387
12.5	0.0318	0.0636	0.0877	0.117	0.168	0.215	0.313
14	0.0309	0.0622	0.0843	0.113	0.159	0.211	0.304
16	0.0243	0.0488	0.068	0.0871	0.126	0.164	0.232
18	0.0238	0.0479	0.0658	0.0849	0.12	0.161	0.226
20			0.0515		0.0925		0.175
22.4			0.0501		0.0892		0.171

1) Nominal Ratio



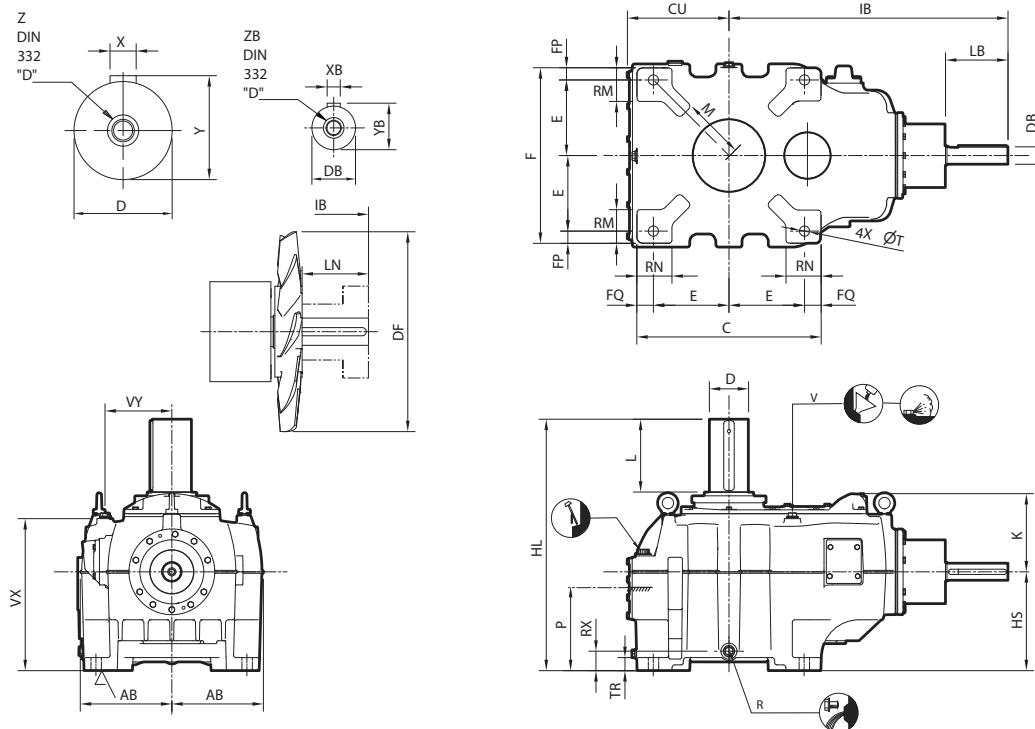

8 Dimensional drawing

Dimensions in mm



Size	AB	C	F	CU	E	FP	FQ	HL	HS	IB	K	M	RM	RN	T	TR	kg	Litres ²⁾
CA	260	480	480	278	200	40	40	765	310	812	240	165	110	110	28	38	495	36
DA	285	540	540	306	225	45	45	825	340	916	270	195	115	115	35	45	650	50
DX	315	632	602	350	260	41	56	865	340	960	270	210	115	120	35	45	800	62
EA	328	610	610	342	260	45	45	935	390	1012	295	225	127	127	35	45	960	74
EX	363	706	694	388	295	52	58	935	390	1064	295	265	144	142	42	52	1170	89
FA	370	690	690	416	295	50	50	1015	440	1119	340	260	140	140	42	52	1380	105
FX	380	710	710	416	305	50	50	1065	440	1178	340	270	150	150	48	65	1620	108

Size	Shafts - Keys							ISO/R773-1969		
	D m7	L	X	Y	Z	DB	LB	XB	YB	ZB
CA	105	210	28	111	M24	50k6	180	14	53,5	M16
DA	115	210	32	122	M24	60m6	210	18	64	M20
DX	135	250	36	143	M30	60m6	210	18	64	M20
EA	135	250	36	143	M30	65m6	210	18	69	M20
EX	155	250	40	164	M30	65m6	210	18	69	M20
FA	155	250	40	164	M30	75m6	210	20	79.5	M20
FX	170	300	40	179	M30	75m6	210	20	79.5	M20

-  Dipstick
-  Oil filling plug
-  Ventilation
-  Draining plug

The user is responsible for the provision of safety guards and correct installation of all equipment.

Certified dimensions upon request.

External dimensions are not affected when mounting a pump and/or backstop.

Size	Fan		Draining		Ventilation		Oil level		
	DF	LN		R	RX	V	VX	VY	P ²⁾
		LN ₁ ¹⁾	LN ₂ ¹⁾						
CA	380	142	116	G 1"	55	G 1"	450	200	287
DA	440	172	146	G 1"	67	G 1"	525	210	312
DX	440	172	146	G 1"	67	G 1"	523	230	312
EA	475	172	146	G 1"	65	G 1"	596	250	357
EX	475	172	146	G 1"	65	G 1"	595	265	357
FA	560	172	146	G 1"	70	G 1"	660	280	387
FX	560	172	146	G 1"	70	G 1"	670	290	387

1) LN₁: for coupling hub diam. ≤ 150 mm, LN₂: for coupling hub diam. > 150 mm

2) Approximate values; only the markings on the gear unit dipstick are determinant for the oil quantity and oil level

Worldwide locations

World Headquarters JAPAN

Sumitomo Heavy Industries Ltd.
PTC Group
Think Park Tower, 1-1
Osaki 2-chome
Shinagawa-ku, Tokyo 141-6025, Japan
www.cyclo.shi.co.jp
www.sumitomodrive.com

Headquarters & Manufacturing CHINA

Sumitomo (SHI) Cyclo Drive China, Ltd. Shanghai Branch
10F, SMEG Plaza, No.1386
Hongqiao Road
Shanghai, China (P.C.200336)

Headquarters & Manufacturing EUROPE

Germany

Sumitomo (SHI) Cyclo Drive Germany GmbH
European Headquarters
Cyclostraße 92
85229 Markt Indersdorf
Germany
Tel. +49 8136 66-0
www.sumitomodrive.com

Headquarters & Manufacturing AMERICAS

Sumitomo Machinery Corp. of America
4200 Holland Boulevard
Chesapeake, VA 23323, USA
www.sumitomodrive.com

Headquarters ASIA PACIFIC

Sumitomo (SHI) Cyclo Drive Asia Pacific Pte. Ltd.
15 Kwong Min Road
Singapore, 628718 Singapore

Belgium

Hansen Industrial Transmissions NV
Leonardo da Vincilaan 1-3
2650 Edegem
Belgium
Tel. +32 3 450 12 11
www.sumitomodrive.com

Our Subsidiaries & Sales Offices in EUROPE, MIDDLE EAST, AFRICA & INDIA

Austria

Sumitomo (SHI) Cyclo Drive Germany GmbH
Sales Office Austria
Gruentalerstraße 30 A
4020 Linz, Austria
Tel. +43 732 330958

Belgium, Netherlands, Luxemburg

Hansen Industrial Transmissions NV
Leonardo da Vincilaan 1-3
2650 Edegem, Belgium
Tel. +32 3 450 12 11

France

SM-Cyclo France S.A.S.
8 Avenue Christian Doppler
77700 Serris, France
Tel. +33 1 64171717

India

Sumi-Cyclo Drive India Pvt. Ltd.
Gat No. 186, Global Raison Industrial Park
Alandi Markal Road, Fulgao
Pune 411 033, India
Tel. +91 20 6674 2900

Italy

SM-Cyclo Italy S.R.L.
Via dell'Artigianato 23
20007 Cornaredo (MI), Italy
Tel. +39 02 93481101

Middle East

Hansen Industrial Transmissions NV
Leonardo da Vincilaan 1-3
2650 Edegem, Belgium
Tel. +32 3 450 12 11

Sweden, Denmark, Norway, Finland, Estonia, Latvia – NORDIC

SM-Cyclo UK, Ltd.
Unit 29, Bergen Way,
Sutton Fields Industrial Estate
Kingston upon Hull
HU7 0YQ, East Yorkshire, United Kingdom
Tel. +44 1482 790340

Spain

Sociedad Industrial de Transmisiones, S.A.
Paseo de Ubarburu, 67
20014 San Sebastián
Tel. + 34 943 457 200

South Africa, Sub-Saharan Africa – Sales Partner

BMG BEARING MAN GROUP (PTY) LTD
PO Box 33431; Jeppestown
Johannesburg 2043; South Africa
Tel. +27 11 620 1615

Turkey

SM Cyclo Güç Aktarım Sis. Tic. Ltd.Sti.
Barbaros Mh. Çiğdem Sk. Ağaoğlu My Office İş Mrk.
No:1 Kat:4 D.18 34746 Ataşehir / Istanbul – Turkey
Tel. +90 216 250 6069

United Kingdom

SM-Cyclo UK, Ltd.
Unit 29, Bergen Way,
Sutton Fields Industrial Estate
Kingston upon Hull
HU7 0YQ, East Yorkshire, United Kingdom
Tel. +44 1482 790340